



Datasheet

MB Series - 240W

Outdoor LED Driver Dimmable(US Standard)

Richmat 豪江

Believe in the Power of Quality

PRODUCT:



FEATURES:

- Efficiency up to 94%
- PF>0.97, THD<7%
- Full power output within recommended operating voltage range
- Constant Current output
- Output current is manually adjustable
- 3 in 1 Dimming Function: 0-10V, PWM, Resistor (Model S)
- Lightning protection level : Difference module 6KV , Common mode 15KV
- IP67 rating for indoor and outdoor
- Protections: BOP, OTP, SCP, OVP- Dimming Interface
- Metal Housing Design with Functional Ground
- Warranty: 5 Years

CERTIFICATIONS:



APPLICATIONS:

LED Street lighting
 LED Sports Lighting
 LED Plant Grows Lighting
 LED Industrial Lighting
 LED fish aggregating Light

PRODUCT OVERVIEW:

The HJ-W240-MB series is a state-of-the-art outdoor constant current driver with an isolated two-stage circuit structure, offering a rated output power of 240W. Leveraging proprietary patented technology, this driver demonstrates exceptional performance across a broad range of input and output conditions. With high energy conversion efficiency, it stands as an environmentally friendly and low-carbon solution. The driver's adjustable output current and precise dimming control make it well-suited for LED lighting applications. It is equipped with comprehensive active and passive protection features, effectively addressing various challenging conditions, ensuring high reliability, and minimizing the failure rate. This product is a cost-effective choice for luminaire manufacturers, contributing to overall cost reduction.

MODULE	Rated input voltage	Rated output power	Output voltage range	Recommended operating voltage	Adjustable range of output current	Power factor	T.H.D	Efficiency	Max. Case Temp.
HJ-W240-V56A-MB	120-277V	240 W	25-56Vdc	34-56Vdc	4.3-6.7A	0.97	7%	93.0%	90°C
HJ-W240-V56S-MB	120-277V	240 W	25-56Vdc	34-56Vdc	4.3-6.7A	0.97	7%	93.0%	90°C
HJ-W240-V343A-MB	120-277V	240 W	171-343Vdc	220-343Vdc	0.5-1.05A	0.97	7%	93.0%	90°C
HJ-W240-V343S-MB	120-277V	240 W	171-343Vdc	220-343Vdc	0.5-1.05A	0.97	7%	93.0%	90°C

Remarks: 1. Test conditions of the above parameters: Ta=25C, 230Vac input, full load operation for 30 minutes;
 2. The driver can operate normally throughout the entire rated output voltage range, ensuring superior performance of the LED driver within the recommended operating voltage range.

INPUT:

Parameter	Min	Typ.	Max	Note
Rated input voltage	120Vac		277Vac	
Input voltage range	108Vac		305Vac	
Input frequency range	47Hz	50/60Hz	63Hz	
Input current			2.5A	120Vac, Full Load
Input power			300W	120Vac, Full Load
Input surge current peak value			70A	120Vac, Cold Start
			100A	230Vac, Cold Start
			120A	277Vac, Cold Start
Power factor	0.97	0.99		120Vac, Full Load
	0.95	0.97		230Vac, Full Load
	0.93	0.95		277Vac, Full Load
	0.9			120-277Vac 50/60Hz, 70-100% Load
Total harmonic distortion		5%	7%	120Vac, Full Load
		7%	9%	230Vac, Full Load
		10%	12%	277Vac, Full Load
			15%	120-277Vac 50/60Hz, 70-100% Load

Remark: All performance parameters are measured at an ambient temperature of 25°C and with the use of LED load, unless otherwise specified.

OUTPUT: HJ-240W-V56A/S-MB

Parameter	Min	Typ.	Max	Note
Output voltage range	25V		56V	
Rated output voltage	36V		56V	At the rated output voltage, the maximum output power $P_o = V_o \cdot I_o = 240W$
Rated output current	4.3A		6.7A	
Default factory output current		5.0A		
Current adjustment range	3.5A		6.7A	Refer to the AOC curve
Maximum no-load output voltage			80V	
Efficiency	88.0%	88.5%		Input 120Vac, Output 36V/6.7A
	90.5%	91.0%		Input 230Vac, Output 36V/6.7A
	91.0%	91.5%		Input 277Vac, Output 36V/6.7A
	89.0%	89.5%		Input 120Vac, Output 56V/4.3A
	91.5%	92.0%		Input 230Vac, Output 56V/4.3A
	92.0%	92.5%		Input 277Vac, Output 56V/4.3A
Current accuracy	-5.0%		+5.0%	100% load Constant Power Range
Output current ripple		5.0%	10%	$\Delta I = I_{pk} - I_{pk} / 2 / I_o \cdot 100\%$
Startup current overshoot			10%	LED Load
Startup time	300ms		1000ms	100%Load@120-277Vac
Linear regulation rate	-3%		+3%	100%Load
Load regulation rate	-3%		+3%	100%Load
Temperature coefficient	-0.03%/°C		+0.03%/°C	Casing Temp. : 0-90°C
Over temperature protection	90°C		100°C	Casing temperature: Prolonged operation at the highest temperature will reduce the reliability of the power supply. Pay attention to heat dissipation when in use.
Short circuit protection			20W	Not damaged by prolonged short circuits, automatic recovery upon fault resolution.
Input undervoltage protection	96Vac	102Vac	108Vac	Derated output, returns to normal after the abnormal condition is resolved.

OUTPUT: HJ-240W-V343A/S-MB

Parameter	Min	Typ.	Max	Note
Output voltage range	171V		343V	
Rated output voltage	228V		343V	At the rated output voltage, the maximum output power $P_o = V_o \cdot I_o = 240W$
Rated output current	0.7A		1.05A	
Default factory output current		0.7A		
Current adjustment range	0.5A		1.05A	Refer to the AOC curve
Maximum no-load output voltage			400V	
Efficiency	89.5%	90.0%		Input 120Vac, Output 228V/1.05A
	92.0%	92.5%		Input 230Vac, Output 228V/1.05A
	92.5%	93.0%		Input 277Vac, Output 228V/1.05A
	90.0%	90.5%		Input 120Vac, Output 343V/0.7A
	93.0%	93.5%		Input 230Vac, Output 343V/0.7A
	93.5%	94.0%		Input 277Vac, Output 343V/0.7A
Current accuracy	-5.0%		+5.0%	100% load Constant Power Range
Output current ripple		7.0%	10%	$\Delta I = I_{pk} - p_k / I_o \cdot 100\%$
Startup current overshoot			10%	LED Load
Startup time	300ms		1000ms	100%Load@120-277Vac
Linear regulation rate	-3%		+3%	100%Load
Load regulation rate	-3%		+3%	100%Load
Temperature coefficient	-0.03%/°C		+0.03%/°C	Casing Temp. : 0-90°C
Over temperature protection	90°C		100°C	Casing temperature: Prolonged operation at the highest temperature will reduce the reliability of the power supply. Pay attention to heat dissipation when in use.
Short circuit protection			20W	Not damaged by prolonged short circuits, automatic recovery upon fault resolution.
Input undervoltage protection	96Vac	102Vac	108Vac	Derated output, returns to normal after the abnormal condition is resolved.

Remark: After adjusting the current, seal the adjustable potentiometer hole with 704 silicone, and cover it with the waterproof plug.

DIMMING:

Parameter	Description	Min	Typ.	Max	Note
0-10V Dimming	External voltage range	0V		12V	DIM+ output 100uA current
	Recommended dimming voltage	1V		10V	
	Dimming output range	10%		100%	DIM+/DIM-reverse connection prohibited.
	Dimming cutoff voltage	0.45V	0.50V	0.55V	
	Dimming start voltage	0.65V	0.70V	0.75V	
PWM Dimming	PWM High	9.8V		10.2V	DIM+ output 100uA current
	PWM Low	0V		0.3V	DIM+/DIM-reverse connection prohibited.
	PWM Frequency	500Hz		2KHz	
	Recommended dimming duty cycle	10%		100%	
	Dimming output range	10%		100%	
	Dimming cutoff duty cycle	4.5%	5.0%	5.5%	
	Dimming start duty cycle	6.5%	7.0%	7.5%	
Resistor Dimming	External resistor	0Ω		100KΩ	DIM+ output 100uA current
	Dimming output range	10%		100.0%	
	Dimming cutoff resistance	4.5KΩ	5.0KΩ	5.5KΩ	
	Dimming start resistance	6.5KΩ	7.0KΩ	7.5Ω	
Interface protection	Interface over voltage protection			400Vdc or 277Vac	Interface not damaged within 30 minutes.

Remarks:

1. The dimming interface can withstand voltages up to 277Vac without damage for a short period (within 30 minutes), and returns to normal operation after the fault is resolved. When the dimming interface is connected to AC mains, the output current decreases to half of the set current value. Construction personnel can quickly identify and resolve faults based on this phenomenon, avoiding permanent damage to the interface.
2. All performance parameters are typical values measured at an ambient temperature of 25°C and with the use of LED load, unless otherwise specified.
3. When the dimming line is not in use, please seal the dimming line connector with insulating tubing to prevent disturbances signals from entering, which could damage the dimming line and affect the normal operation of the power supply.

OTHER:

Parameter	Description	Note
Estimation of Mean Time Between Failures (MTBF)	180,500 hours	230Vac, full load, ambient temperature 25°C (MIL-HDBK-217F).
Lifetime	50,000 hours	230Vac, full load, Tc=75°C
International Protection	IP67	Suitable for dry and humid environments, avoid prolonged exposure to rain.
Maximum casing temperature	90°C	
Warranty	5Years	Casing temperature (Tc point) not exceeding 75°C
Weight	1.0kg	Net weight
Dimension	217mm*63mm*37mm	Length * Width * Height

ENVIRONMENT:

Parameter	Min	Typ.	Max	Note
Operating temperature	-40°C	60°C	90°C	Casing temperature
Operating humidity	10%RH		90%RH	No condensation
Storage temperature	-40°C	25°C	90°C	
Storage humidity	10%RH		90%RH	No condensation

Safety and EMC:

Items	Standard	Note
CCC	GB 19510.14-2009、GB/T 17743-2021、 GB17625.1-2022	
ENEC	EN 61347-1:2015 EN 61347-2-13:2014 EN 61347-2-13:2014/A1:2017	
CB	IEC 61347-1, IEC 61347-2-13-2016	
CE	EN 61347-2-13:2014 EN61347-1:2008+A1:2011+A2:2013	
UL	UL8750	
Conducted emission	EN 55015/GB 17743 FCC Part 15 Subpart B	Conducted emission Test & Radiated emission Test
Radiated emission		
Harmonics Current	EN 61000-3-2	Harmonic current emissions
Voltage flicker	EN 61000-3-3	Voltage Fluctuations & Flicker
ESD	EN 61000-4-2	Electrostatic Discharge (ESD): 8 kV air discharge, 4 kV contact discharge
Radiated Susceptibility	EN 61000-4-3	Radio-Frequency Electromagnetic Field Susceptibility Test-RS
Surge (transient)	EN 61000-4-5	Surge Immunity Test: Differential Mode 6 kV, Common Mode 15 kV
Conducted immunity	EN 61000-4-6	Conducted Radio Frequency Disturbances Test-CS
Power frequency magnetic field	EN 61000-4-8	Power Frequency Magnetic Field Test
Voltage dips and interruption	EN 61000-4-11	Voltage Dips
Immunity of lighting equipment	EN 61547	Electromagnetic Immunity Requirements Applies To Lighting Equipment
Oscillatory wave immunity	EN 61000-4-12	Oscillatory Waves Immunity Test
Insulation	I/P-O/P, I/P-FG, O/P-FG:100MΩ / 500VDC / 25°C/ 70% RH	
Dielectric strength	I/P-O/P:3.75kVac I/P-FG:1.5kVac O/P-FG:500Vac I/P-DIM&Vaux:3.75kVac O/P-DIM&Vaux:1.5kVac DIM&Vaux-FG:1.5kV	
Ground resistance	<0.1Ω, 25A/1min	
Leakage current	<0.75mA 277Vac	

Note: The power supply complies with relevant EMC standards. As part of the terminal equipment system, EMC needs to be reconfirmed in conjunction with the entire system.

Characteristics Curve:

Vin	Peak current	Duration (@10% peak current)	Duration (@50% peak current)
120Vac	55A	685us	205us
230Vac	90A	695us	210us
277Vac	115A	650us	215us

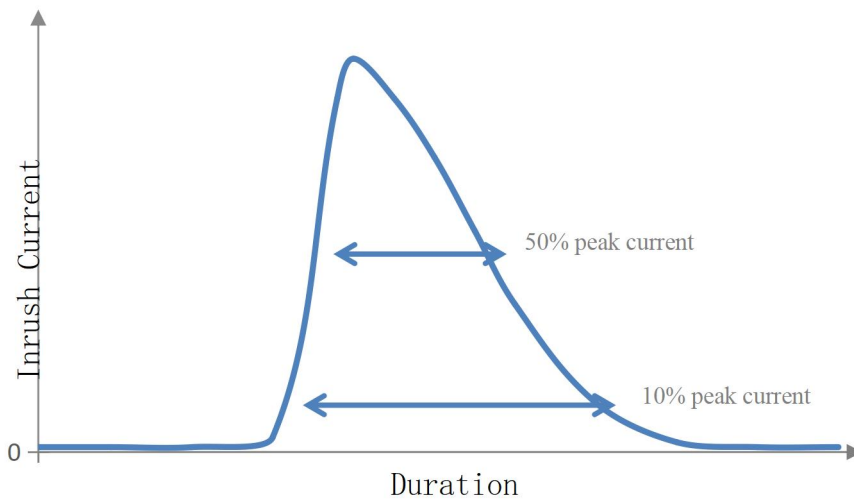

Fig.1. Inrush Current VS Duration

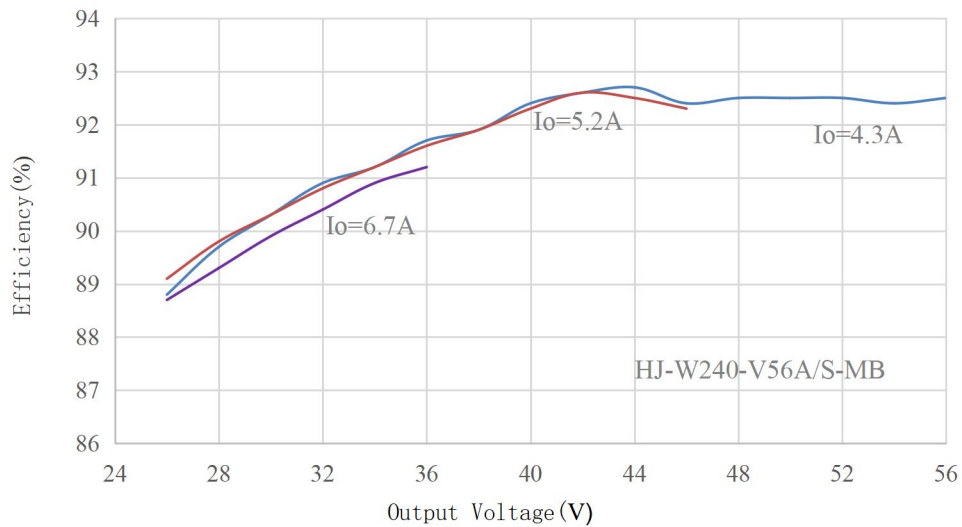

Fig.2. Efficiency VS Output Voltage

Characteristics Curve:

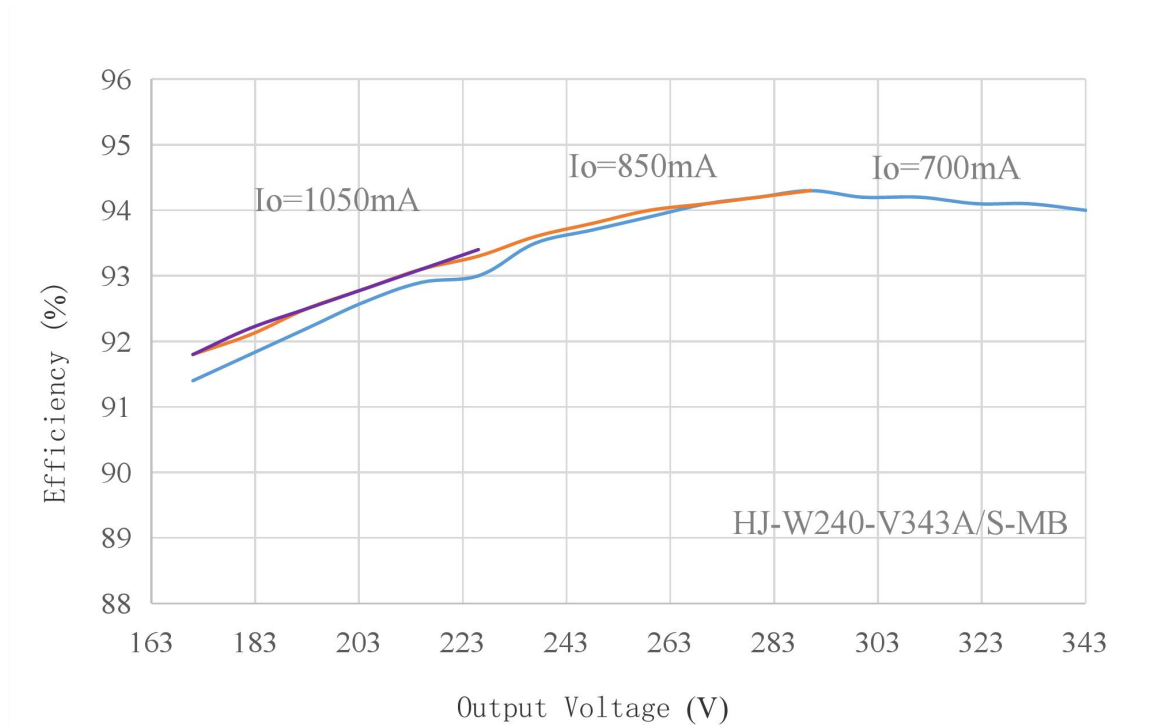

Fig. 3. Efficiency VS Output Voltage

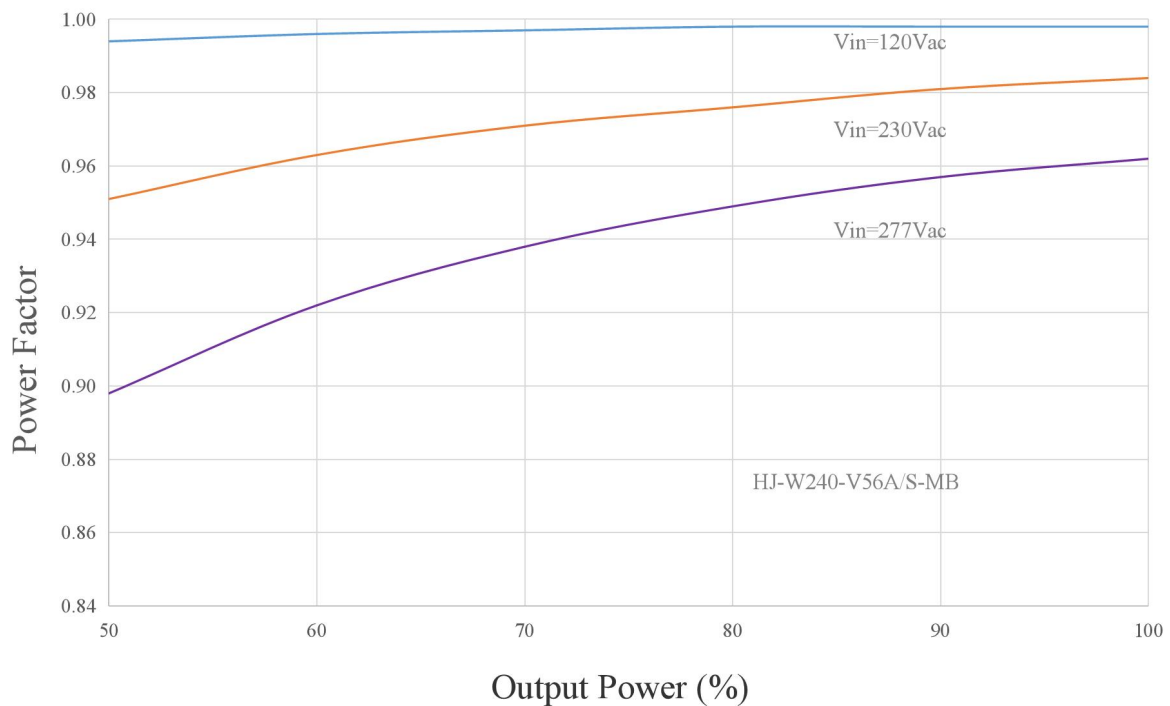

Fig 4. Power Factor VS Output Power

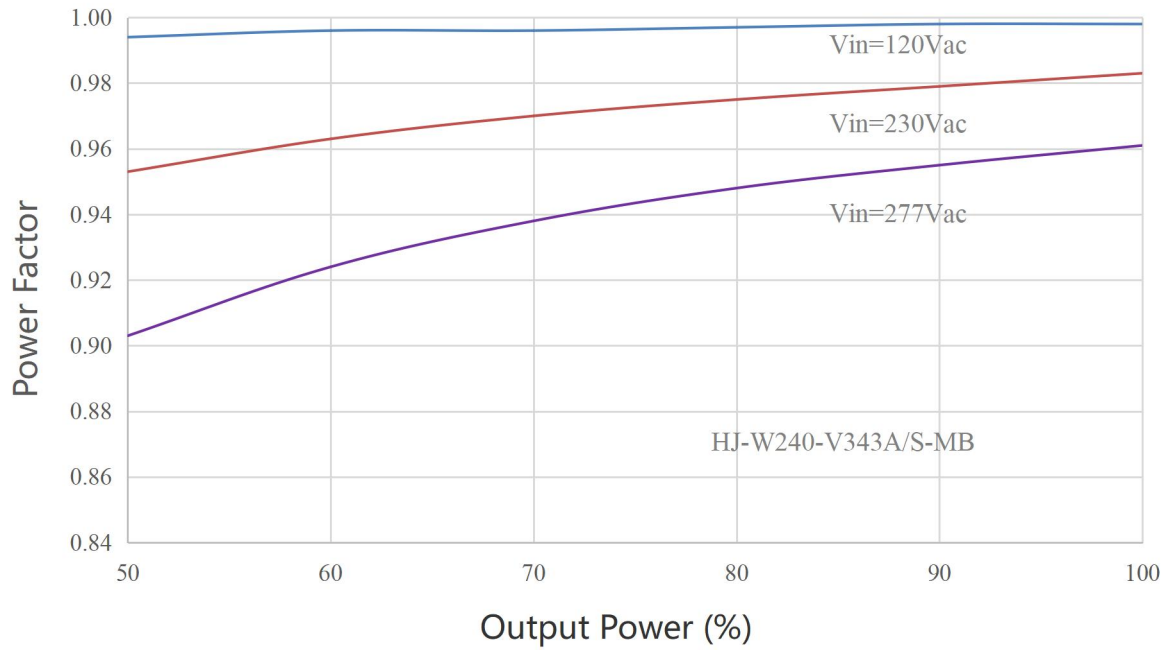

Fig 5. Power Factor VS Out Power

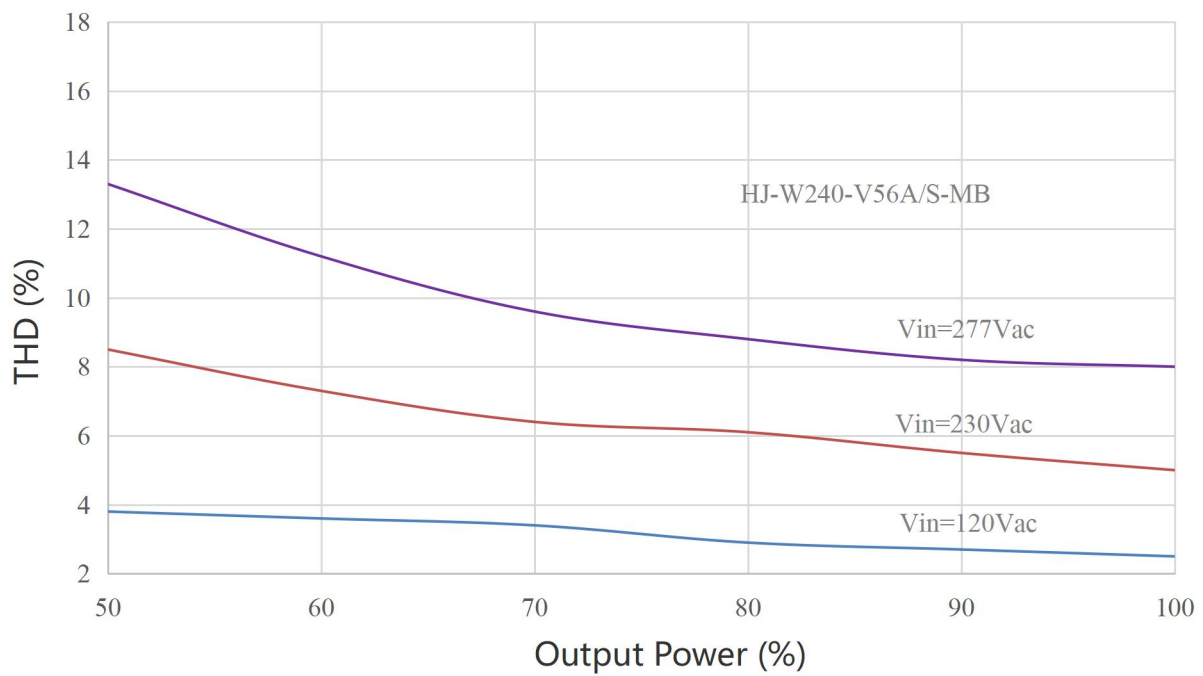

Fig.6 THD VS Output Power

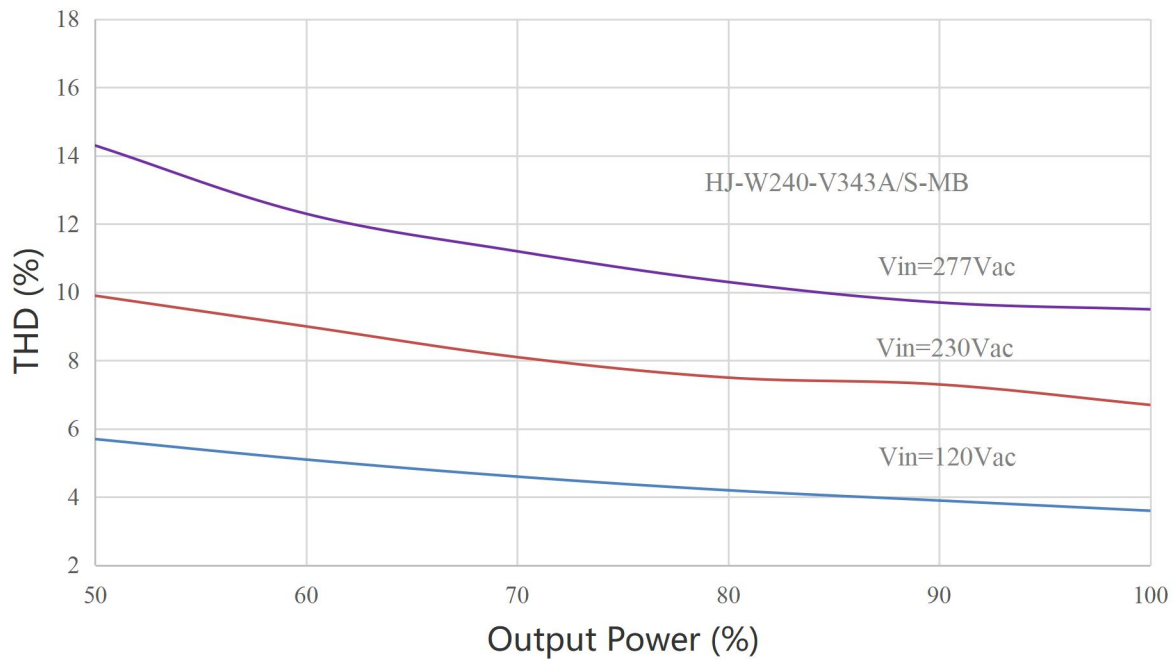

Fig 7. THD VS Output Power

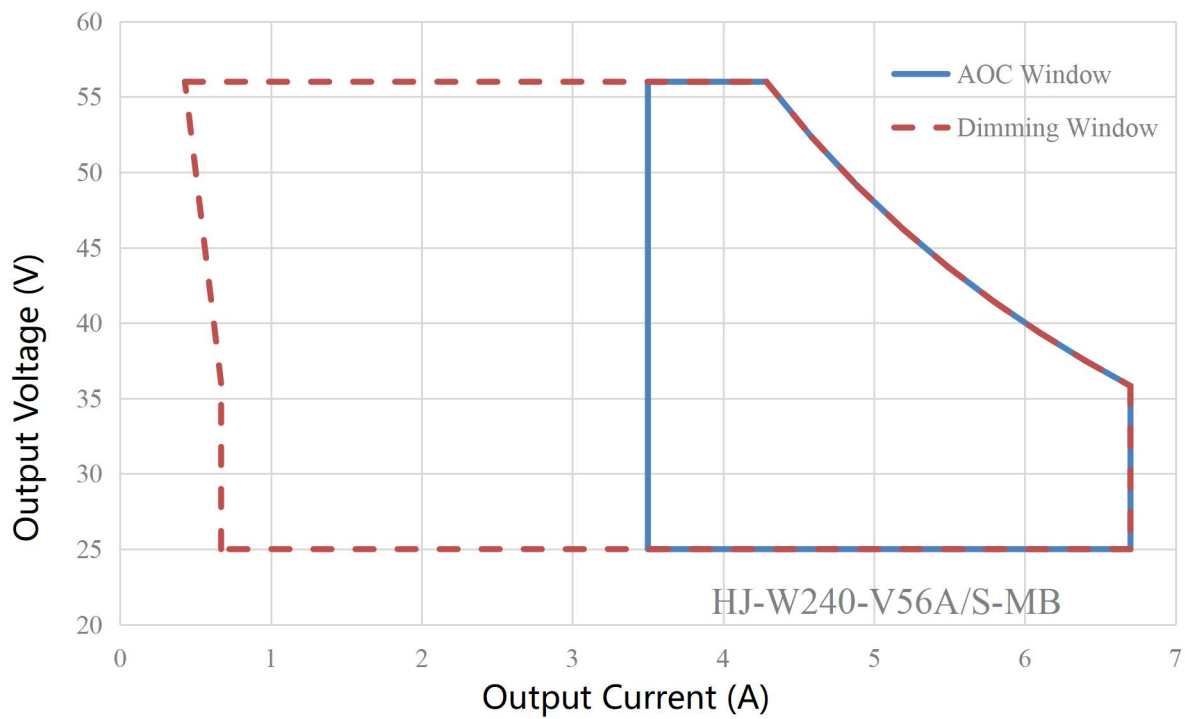

Fig 8. Output Voltage VS Output Current (Dimming/AOC Window)

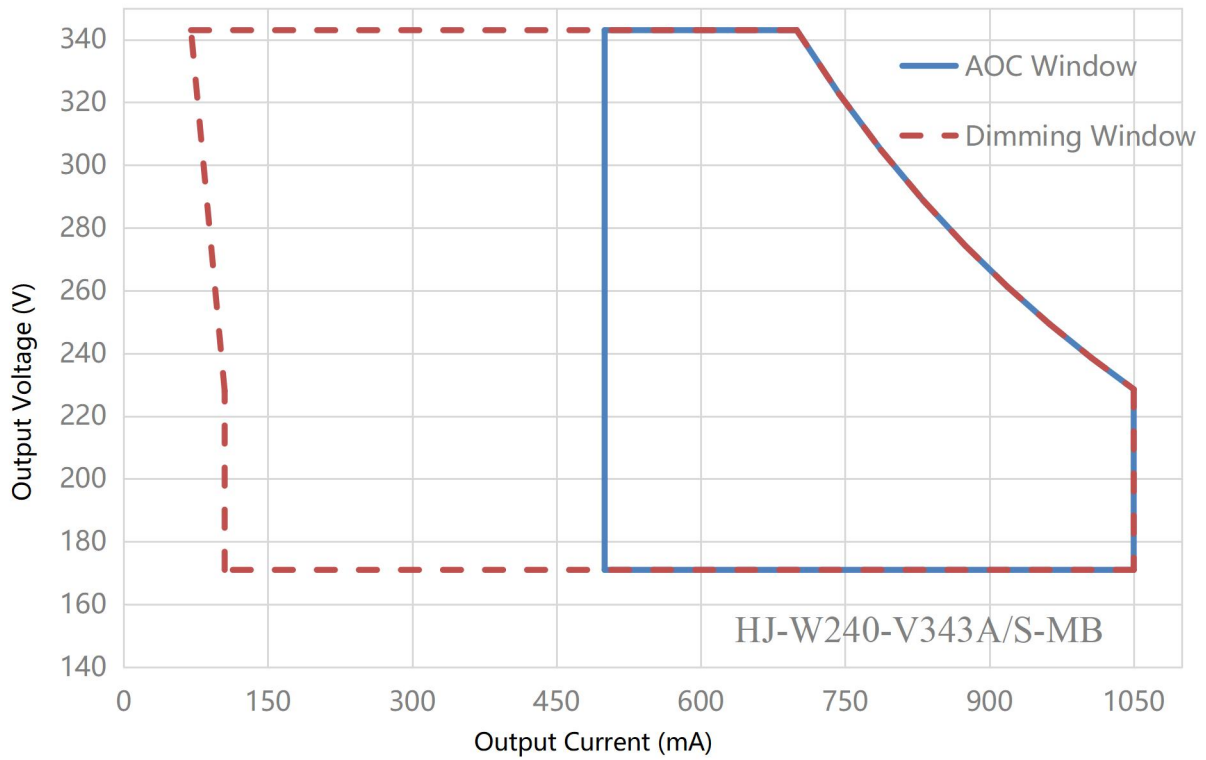

Fig 9. Output Voltage VS Output Current (Dimming/AOC Window)

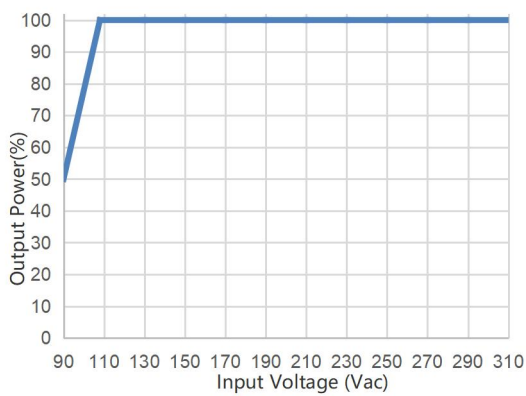

Fig 10. Output Power VS Input Voltage

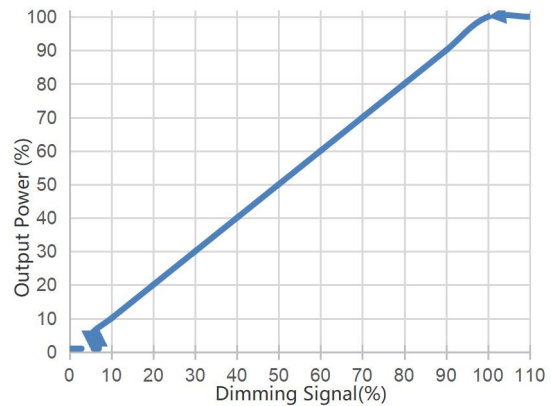

Fig 11. Output Power VS Dimming Signal

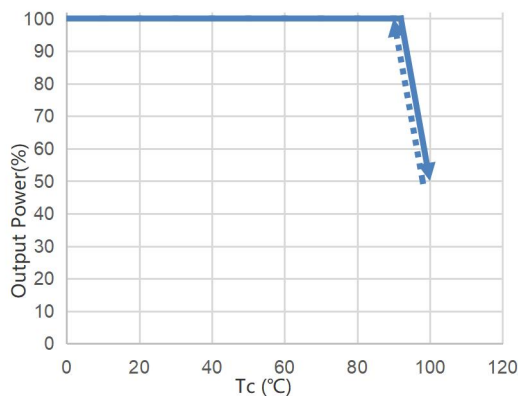

Fig 12. Output Power VS Tc

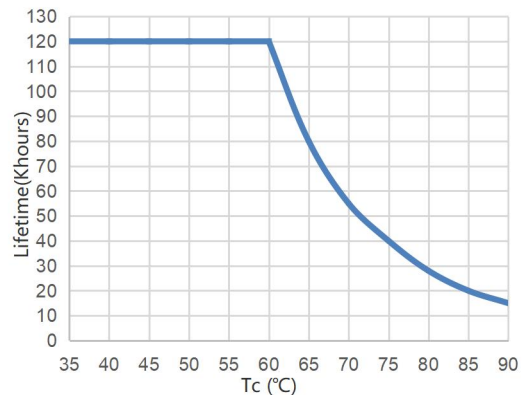
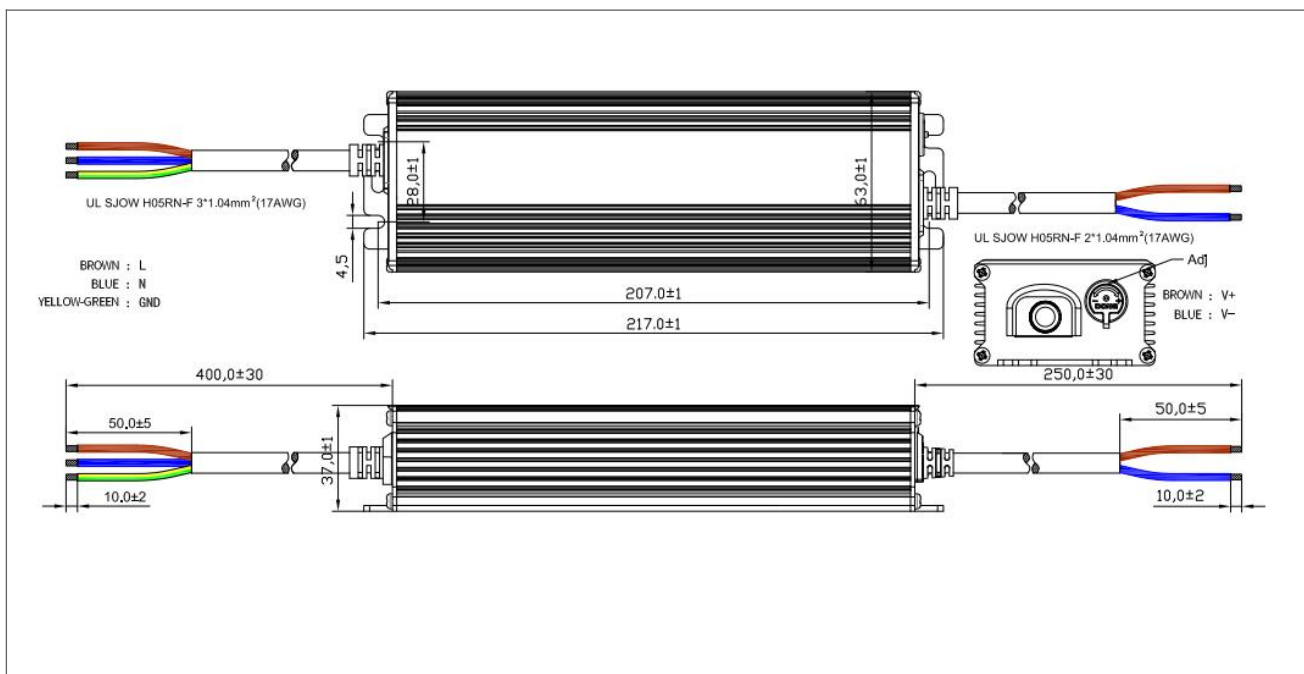

Fig 13. Lifetime VS Tc

Mechanical Specification:

HJ-W240-V56/343A-MB



HJ-W240-V56/343S-MB

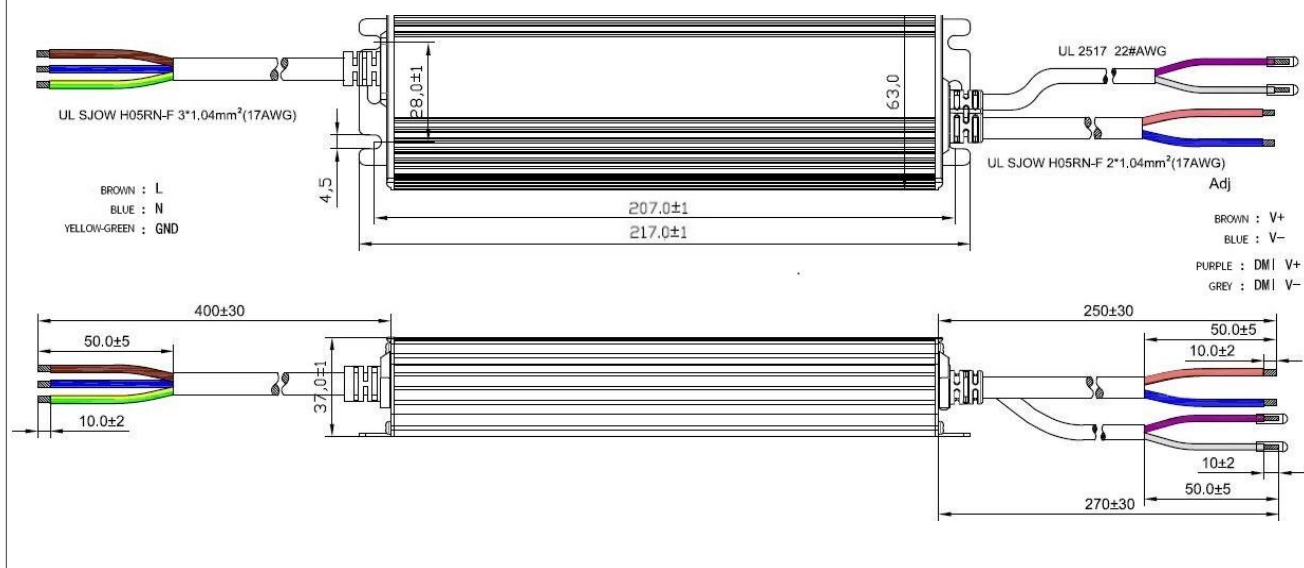

Packaging:

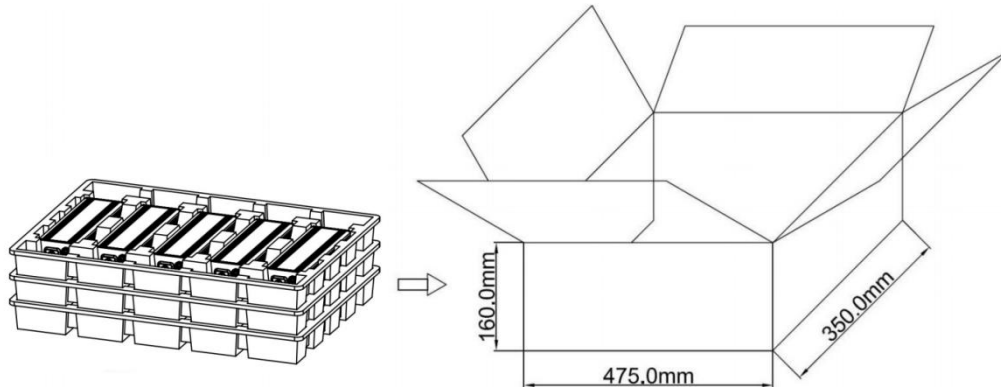

Packaging Description:

- The external dimensions of the packaging box (unit: mm) are: Length x Width x Height = 475 x 350 x 160;
- Each box contains 15 units, arranged in 3 layers with 5 units per layer. The gross weight is 16 Kg;
- Net weight per unit: 1 kg;
- The packaging box includes product name, model, manufacturer's identification, quality department's inspection certificate, manufacturing date, and other information.

Shipping:

The packaging is suitable for transportation by car, ship, and airplane. During transport, it should be protected from moisture, sunlight, and handled with care during loading and unloading.

Storage:

Product storage should comply with the provisions of GB 3873-83. Products stored for more than 1 year should undergo re-inspection, and only after passing the inspection can they be used.

RoHS:

The product complies with the European Union RoHS Directive (2011/65/EU) and the European Parliament Amendment 2015/863/EU.

Update History:

Versions	Description of Update	Update Date	Note
V00	Initial release	2023.08.23	
V01	Correction of Text Description in Figure 12	2023.09.03	

Edit	Audit	Approval